

MAX®

HVR41-ST(CE)

COLLATED SCREW FASTENING SYSTEM



OPERATING and MAINTENANCE MANUAL

 **WARNING:**

BEFORE USING THIS TOOL, STUDY THIS MANUAL TO ENSURE SAFETY WARNING AND INSTRUCTIONS.

KEEP THESE INSTRUCTIONS WITH THE TOOL FOR FUTURE REFERENCE.

INDEX

ENGLISH Page 3 to 18 Page

DEFINITIONS OF SIGNAL WORDS

- WARNING:** Indicates a potentially hazardous situation which, if not avoided, could result in death or serious injury.
- CAUTION:** Indicates a potentially hazardous situation which, if not avoided, may result in minor or moderate injury.
- NOTE :** Emphasizes essential information.

ENGLISH

HVR41-ST(CE)

COLLATED SCREW FASTENING SYSTEM

INDEX

1. SAFETY INSTRUCTIONS.....	4
2. SPECIFICATIONS & TECHNICAL DATA..	7
3. AIR SUPPLY AND CONNECTIONS	8
4. INSTRUCTIONS FOR OPERATION	9
5. HOW TO REPLACE THE BIT	14
6. MAINTAIN FOR PERFORMANCE.....	18
7. STORING	18
8. TROUBLESHOOTING/REPAIRS	18

OPERATING and MAINTENANCE MANUAL



BEFORE USING THIS TOOL, STUDY THIS MANUAL TO ENSURE SAFETY WARNING AND INSTRUCTIONS.

KEEP THESE INSTRUCTIONS WITH THE TOOL FOR FUTURE REFERENCE.

1. SAFETY INSTRUCTIONS



▲ WARNING:
TO AVOID SEVERE PERSONAL INJURY OR PROPERTY DAMAGE
BEFORE USING THE TOOL, READ CAREFULLY AND UNDERSTAND THE FOLLOWING "SAFETY INSTRUCTIONS". FAILURE TO FOLLOW WARNINGS COULD RESULT IN DEATH OR SERIOUS INJURY.

PRECAUTIONS ON USING THE TOOL



1. WEAR SAFETY GLASSES OR GOGGLES

Danger to the eyes always exists due to the possibility of dust being blown up by the exhausted air or of a fastener flying up due to the improper handling of the tool. For these reasons, safety glasses or goggles shall always be worn when operating the tool.

The employer and/or user must ensure that proper eye protection is worn. Eye protection equipment must conform to the requirements of the American National Standards Institute, ANSI Z87.1 (Council Directive 89/686/EEC of 21 DEC. 1989) and provide both frontal and side protection.

The employer is responsible to enforce the use of eye protection equipment by the tool operator and all other personnel in the work area.

NOTE: Non-side shielded spectacles and face shields alone do not provide adequate protection.



2. EAR PROTECTION MAY BE REQUIRED IN SOME ENVIRONMENTS

As the working condition may include exposure to high noise levels which can lead to hearing damage, the employer and user should ensure that any necessary hearing protection is provided and used by the operator and others in the work area.



3. WHEN USING THE TOOL, BE SURE TO USE A SPECIAL AIR COMPRESSOR AND AIR HOSE

In order to improve its performance, it has set its working pressure higher than the conventional nailers. To use the tool, you always need the special air compressor and air hose. Use of combustible pressure gas (for example, oxygen, acetylene, etc.) causes abnormal combustion, possibly resulting in explosion. Use only the special air compressor and air hose.



4. OPERATE WITHIN THE PROPER AIR PRESSURE RANGE

The tool is designed to operate within an air pressure range of 18 to 23 bar (250 to 320 p.s.i.).

The pressure should be adjusted to the type of the work being fastened. The tool shall never be operated when the operating pressure exceeds 23 bar (320 p.s.i.).



5. DO NOT OPERATE THE TOOL NEAR A FLAMMABLE SUBSTANCE

Never operate the tool near a flammable substance (e.g., thinner, gasoline, etc.). Volatile fumes from these substances could be drawn into the compressor and compressed together with the air and this could result in an explosion.

6. DO NOT USE A WRONG FITTINGS

The connector on the tool must not hold pressure when air supply is disconnected. If a wrong fitting is used, the tool can remain charged with air after disconnecting and thus will be able to drive a fastener even after the air line is disconnected, possibly causing injury.



7. DISCONNECT THE AIR SUPPLY AND EMPTY THE MAGAZINE WHEN THE TOOL IS NOT IN USE

Always disconnect the air supply from the tool and empty the magazine when operation has been completed or suspended, when unattended, moving to a different work area, adjusting, disassembling, or repairing the tool, and when clearing a jammed fastener.



8. INSPECT SCREW TIGHTNESS

Loose or improperly installed screws or bolts cause accidents and tool damage when the tool is put into operation. Inspect to confirm that all screws and bolts are tight and properly installed prior to operating the tool.



9. DO NOT TOUCH THE TRIGGER UNLESS YOU INTEND TO DRIVE A FASTENER

Whenever the air supply is connected to the tool, never touch the trigger unless you intend to drive a fastener into the work. It is dangerous to walk around carrying the tool with the trigger pulled, and this and similar actions should be avoided.



10. NEVER POINT THE DISCHARGE OUTLET TOWARD YOURSELF AND OTHER PERSONNEL

If the discharge outlet is pointed toward people, serious accidents may be caused when misfiring. Be sure the discharge outlet is not pointed toward people when connecting and disconnecting the hose, loading and unloading the fasteners or similar operations.

11. USE SPECIFIED FASTENERS (SEE PAGE 7)

The use of fasteners other than specified fasteners will cause the tool malfunction. Be sure to use only specified fasteners when operating the tool.

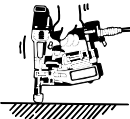

12. PLACE THE DISCHARGE OUTLET ON THE WORK SURFACE PROPERLY

Failure to place the discharge outlet of the nose in a proper manner can result in a fastener flying up and is extremely dangerous.



13. KEEP HANDS AND BODY AWAY FROM THE DISCHARGE OUTLET

When loading and using the tool, never place a hand or any part of body in fastener discharge area of the tool. It is very dangerous to hit the hands or body by mistake.



14. DO NOT DRIVE FASTENERS CLOSE TO THE EDGE AND CORNER OF THE WORK AND THIN MATERIAL

The workpiece is likely to split and the fastener could fly free and hit someone.



15. DO NOT DRIVE FASTENERS ON TOP OF OTHER FASTENERS

Driving fasteners on the top of other fasteners may cause deflection fasteners which could cause injury.

16. REMOVING THE FASTENERS AFTER COMPLETING OPERATION

If fasteners are left in the magazine after the completion of operation, there is the danger of a serious accident occurring prior to the resumption of operation, should the tool be handled carelessly, or when connecting the air fitting. For this reason, always remove all fasteners remaining in the magazine after completion of the operation.

17. CHECK OPERATION OF THE CONTACT TRIP MECHANISM FREQUENTLY IN CASE OF USING A CONTACT TRIP TYPE TOOL

Do not use the tool if the trip is not working correctly as accidental driving of a fastener may result. Do not interfere with the proper operation of the contact trip mechanism.

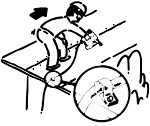

18. WHEN USING THE TOOL OUTSIDE OR ELEVATED PLACE

When fastening roofs or similar slanted surface, start fastening at the lower part and gradually work your way up. Fastening backward is dangerous as you may loose your foot place.
Secure the hose at a point close to the area you are going to drive fasteners. Accidents may be caused due to the hose being pulled inadvertently or getting caught.

19. NEVER USE THE TOOL IF ANY PORTION OF THE TOOL CONTROLS (e.g., TRIGGER, CONTACT ARM) IS INOPERABLE, DISCONNECTED, ALTERED OR NOT WOKING PROPERLY

20. NEVER ACTUATE THE TOOL INTO FREE SPACE

This will avoid any hazard caused by free flying fasteners and excessive strain of the tool.

21. ALWAYS ASSUME THAT THE TOOL CONTAINS FASTENERS

22. RESPECT THE TOOL AS A WORKING IMPLEMENT

23. NO HORSEPLAY

24. NEVER LOAD THE TOOL WITH FASTENERS WHEN ANY ONE OF THE OPERATING CONTROLS (e.g., TRIGGER, CONTACT ARM) IS ACTIVATED

OBSERVE THE FOLLOWING GENERAL CAUTION IN ADDITION TO THE OTHER WARNINGS CONTAINED IN THIS MANUAL

- Do not use the tool as a hammer.
- Always carry the tool by the handle, never carry the tool by the air hose.
- The tool must be used only for the purpose it was designed.
- Never remove, tamper with the operating controls (e.g., TRIGGER, CONTACT ARM)
- Keep the tool in a dry place out of reach of children when not in use.
- Do not use the tool without Safety Warning label.
- Do not modify the tool from original design or function without approval by MAX CO., LTD.

2. SPECIFICATIONS AND TECHNICAL DATA

1. NAME OF PARTS

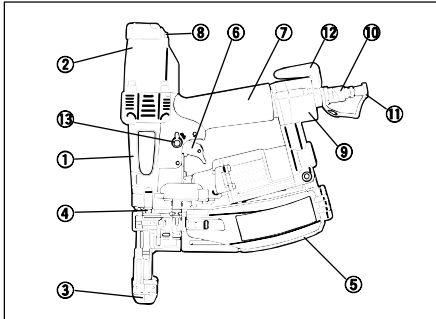

- ① Frame
- ② Cylinder Cap
- ③ Contact Arm
- ④ Nose
- ⑤ Magazine
- ⑥ Trigger
- ⑦ Grip
- ⑧ Charge over Lever
- ⑨ Regulator
- ⑩ Air Plug
- ⑪ End Plug Cap
- ⑫ Hook
- ⑬ Trigger Lock Dial

2. TOOL SPECIFICATIONS

HEIGHT	341 mm (13-1/2")
WIDTH	115 mm (4-1/2")
LENGTH	300 mm (11-3/4")
WEIGHT	2.1 kg (4.63 lbs.)
RECOMMENDED OPERATING PRESSURE	18 to 23 bar (250 to 320 p.s.i.)
LOADING CAPACITY	100 Screws
AIR CONSUMPTION	1.6L at 17.8 bar (258 p.s.i.) operating pressure
ACCESSORIES	Hex. bar wrench, Jet oiler

3. FASTENER SPECIFICATIONS

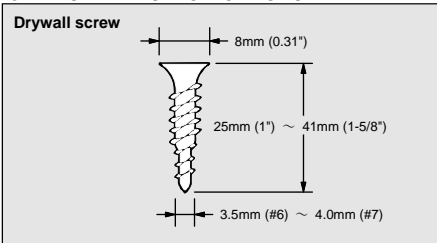

RECOMMENDED OPERATING PRESSURE:

18 to 23 bar (250 to 320 p.s.i.). Select the operating air pressure within this range for best fastener performance.

DO NOT EXCEED 23 bar (320 p.s.i.).

4. TECHNICAL DATA

① NOISE

A-weighted single-event sound power level ----- LWA, 1s, d 95.75 dB

A-weighted single-event emission sound pressure level at work station ----- LpA, 1s, d 87.76 dB

These values are determined and documented in accordance to EN12549 : 1999.

② VIBRATION

Vibration characteristic value = 1.84 m/s^2

These values are determined and documented in accordance to ISO 8662-11.

This value is a tool-related characteristic value and does not represent the influence to the hand-arm-system when using the tool. An influence to the hand-arm-system when using the tool will for example depend on the gripping force, the contact pressure force, the working direction, the adjustment of mains supply, the workpiece, the workpiece support.

5. APPLICATIONS

* Fastening gypsumboard, decorative board, and other interior boards.

▲ WARNING:

3. AIR SUPPLY AND CONNECTIONS

Read section titled “ SAFETY INSTRUCTIONS ”.



DO NOT USE ANY POWER SOURCE EXCEPT AN AIR COMPRESSOR

The tool is designed to operate on compressed air. Do not operate the tool on any other combustible gases (e.g., oxygen, acetylene, etc.) since there is the danger of an explosion. For this reason, absolutely do not use anything other than an air compressor to operate the tool.



OPERATE WITHIN THE PROPER AIR PRESSURE RANGE

The tool is designed to operate within an air pressure range of 18 to 23 bar (250 to 320 p.s.i.). The pressure should be adjusted to the type of the work being fastened. The tool shall never be operated when the operating pressure exceeds 23 bar (320 p.s.i.).



DO NOT OPERATE THE TOOL NEAR A FLAMMABLE SUBSTANCE

Never operate the tool near a flammable substance (e.g., thinner, gasoline, etc.). Volatile fumes from these substances could be drawn into the compressor and compressed together with the air and this could result in an explosion.

DO NOT USE A WRONG FITTINGS

The connector on the tool must not hold pressure when air supply is disconnected. If a wrong fitting is used, the tool can remain charged with air after disconnecting and thus will be able to drive a fastener even after the air line is disconnected, possibly causing injury.



DISCONNECT THE AIR SUPPLY AND EMPTY THE MAGAZINE WHEN THE TOOL IS NOT IN USE

Always disconnect the air supply from the tool and empty the magazine when operation has been completed or suspended, when unattended, moving to a different work area, adjusting, disassembling, or repairing the tool, and when clearing a jammed fastener.

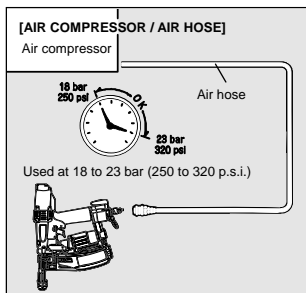

WHEN USING THE TOOL, BE SURE TO USE A SPECIAL AIR COMPRESSOR AND AIR HOSE.

In order to improve its performance, it has set its working pressure higher than the conventional nailers. To use the tool, you always need the special air compressor and air hose (MAX PowerLite Compressor and MAX PowerLite Hose). Use of high-pressure gas (for example, oxygen, acetylene, etc.) causes abnormal combustion, possibly resulting in explosion. Use only the special air compressor and air hose.

NOTE:

Frequent, but not excessive, lubrication is required for the best performance. Oil added thru the air line connection will lubricate the internal parts.

4. INSTRUCTIONS FOR OPERATION

Read section titled “SAFETY INSTRUCTIONS”.

1. BEFORE OPERATION

- ① Wear Safety Glasses or Goggles.
- ② Do not connect the air supply.
- ③ Inspect screw tightness.
- ④ Check operation of the contact arm & trigger if moving smoothly.
- ⑤ Connect the air supply.
- ⑥ Check the air-leakage. (The Tool must not have the air-leakage.)
- ⑦ Hold the Tool with finger-off the trigger, then push the contact arm against the work-piece. (The tool must not operate.)
- ⑧ Hold the Tool with contact arm free from work-piece and pull the trigger. (The Tool must not operate.)
- ⑨ Disconnect the air supply.

WARNING:

2. OPERATION

Wear safety glasses or goggles

Danger to the eyes always exists due to the possibility of dust being blown up by the exhausted air or of a fastener flying up due to the improper handling of the tool. For these reasons, safety glasses or goggles shall always be worn when operating the tool.

The employer and/or user must ensure that proper eye protection is worn. Eye protection equipment must conform to the requirements of the American National Standards Institute, ANSI Z87.1 (Council Directive 89/686/EEC of 21 DEC. 1989) and provide both frontal and side protection.

The employer is responsible to enforce the use of eye protection equipment by the tool operator and all other personnel in the work area.

NOTE: Non-side shielded spectacles and face shields alone do not provide adequate protection.



WARNING:

Keep hands and body away from the discharge outlet when driving the fasteners because of dangerous of hitting the hands or body by mistake.

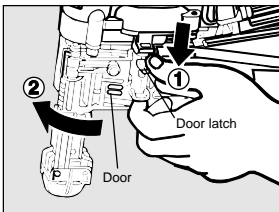

SCREW LOADING

- ① Open the magazine.
Pull down door latch and swing door open. Swing magazine cover open.

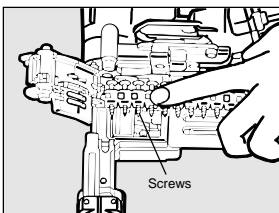

- ② Screw loading.
Place a coil of screws in the magazine. Uncoil enough screws to reach the feed pawl, and place the second screw on the feed pawl. The screw heads fit in slot on the nose.

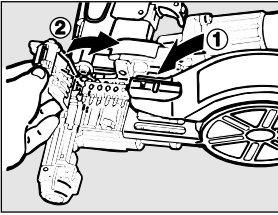

- ③ Swing magazine cover closed.
- ④ Close the door.
Check that latch engages. (If it does not engage, check that the screw heads are in the slot on the nose.)

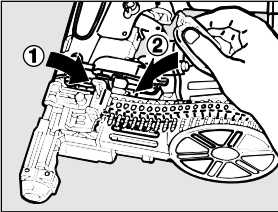

※ It is also possible to close the door first, followed by the magazine cover.

TEST OPERATION

- ① Adjust the air pressure at 18 bar (250 p.s.i.) and connect the air supply.
- ② Without touching the trigger, depress the contact arm against the work-piece.
Pull the trigger. (The tool must fire the fastener.)
- ③ Adjust the air pressure as much as the lowest possible according to the diameters and length of fastener and the hardness of work-piece.

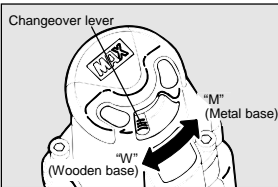

CHANGEOVER LEVER

This tool has a changeover lever mechanism, which allows optimum (drivability, speed) screwing work depending on the condition of the driven-side base material.

NOTE:

- It is recommended to set the changeover lever to an appropriate position suitable for the condition of the driven-side base material.

CHANGEOVER LEVER POSITION

Lever position	Driven base material condition	
	Base material	Top material
"W" (wooden base)	Wooden	Drywall board (9.5 to 15 mm thick), 1 or 2 pcs.
"M" (metal base)	Metal (under 0.8 mm thick)	Drywall board (9.5 to 15 mm thick), 1 or 2 pcs.

Base material	Number of boards	Lever position	
		"W"	"M"
Wooden	1 pc.	◎	○
	2 pcs.	◎	○
Metal	1 pc.	○	◎
	2 pcs.	×	◎

- ◎ : ptimum
- : rivable
- × : Cannot drive

NOTE:

- For the condition of the metal base material and 2 pcs. of drywall boards, you cannot drive at the changeover lever position of "W".
- The changeover lever should be properly operated and set to the position of "W" or "M" until it clicks.

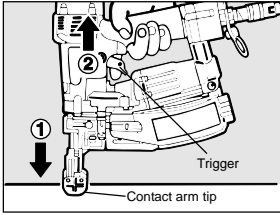

DRIVING FASTENERS

PROCEDURE

Press the contact arm tip against the work surface where the screw is to be driven and then pull the trigger completely down.

- ① Press the contact arm tip against the work surface.
- ② Pull the trigger.

SEQUENTIAL TRIP

The sequential trip requires the operator to hold the tool against the work before pulling the trigger. The sequential trip allows exact fastener location without the possibility of driving a second fastener on recoil. The sequential trip tool has a positive safety advantage because it will not accidentally drive a fastener if the tool is contacted against the work-or anything else-while the operator is holding the trigger pulled.

NOTE:

- ① Hold down the tool firmly until the motor stops running.
- ② If the trigger is released too early, the screw may come loose or cannot be fed properly.

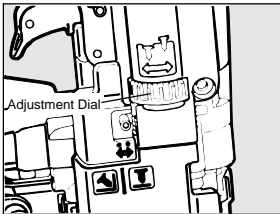

DRIVING DEPTH ADJUSTMENT DIAL



ALWAYS disconnect air supply before adjustment dial.

- ① With air pressure set, drive nails into a representative material sample to determine if adjustment is necessary.
- ② If adjustment is required, disconnect air supply.
- ③ Refer to the mark on the Adjust Spacer for direction to turn the adjustment dial.
- ④ Reconnect air supply.

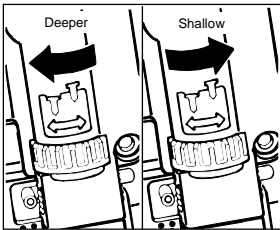

HOW TO USE SINGLE-TOUCH ADJUSTER



ALWAYS disconnect air supply before using single-touch adjuster.

When it is inevitable to drive a screw slantly such as corner driving, this tool can sink under the board surface by single-touch operation.

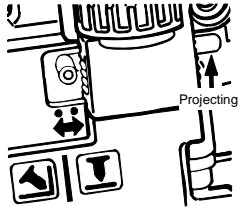
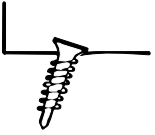
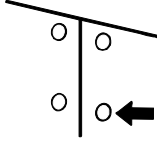
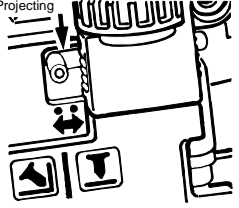
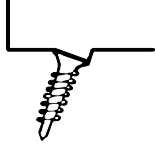
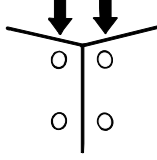
	Adjuster position	Screw	Application
Flat driving			 Use for flat driving
Slant driving			 Use for slant driving

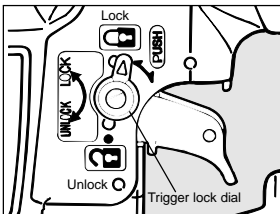

TRIGGER LOCK MECHANISM

The tool is equipped with a trigger lock mechanism. Push and rotate the trigger LOCK to the trigger UNLOCK position before driving screws.

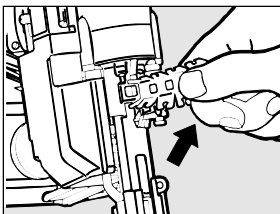

HOW TO REMOVE PLASTIC SHEET

As screws are driven the plastic sheet will feed out of the tool. When sufficient strip has been fed out it can be torn away by pulling against the tear edge in the nose.

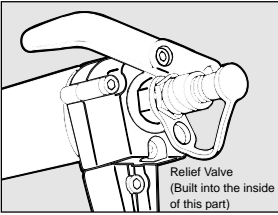

RELIEF VALVE

This tool incorporates a high pressure reduction valve for reducing the range of pressure used at the PowerLine Hose side (18 to 23 bar (250 to 320 p.s.i.)) to a pressure around 8 bar (120 p.s.i.).

In a situation where the high pressure reduction valve fails and pressure builds inside the tool, a relief valve will operate to release the pressure while emitting a sound. Because this shows that the high pressure reduction valve has failed, immediately discontinue use of the machine, disconnect the air supply, and send it to be repaired by a MAX Co., Ltd. authorized distributor or other specialist. Note that the relief valve is built in to the rear part of the machine body.

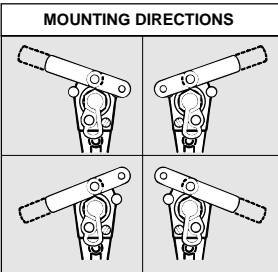

METHOD OF CHANGING THE HOOK DIRECTION



ALWAYS disconnect the air supply before changing the direction of the hook.

The direction of the hook can be changed in four different directions, and the hook width can also be adjusted in two stages for each direction. This allows adjustment in a total of eight patterns.

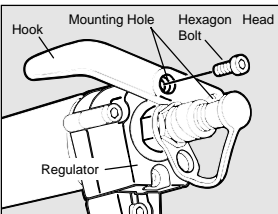

When changing the direction or width of the hook, use a hexagonal bar wrench 4 to loosen and remove the hexagon head bolt that fixes the hook. After adjusting the hook position, replace and tighten the hexagon head bolt.

5. HOW TO REPLACE THE BIT

WARNING:

ALWAYS disconnect air supply before changing a bit.

NOTE:

- ① Pay attention on changing the bit so that sand, dust any foreign substance, etc. do not enter the tool. Inclusion of that can cause the tool failure.
- ② A bit is a consumable part, use of a worn bit deteriorates work efficiency and causes defective screw fastening. Inspect the bit before starting work and change it if it is worn.
- ③ Use the "TURBO DRIVER BIT B341H2" which is optionally available at the MAX Co., Ltd. authorized distributors or by other specialists.

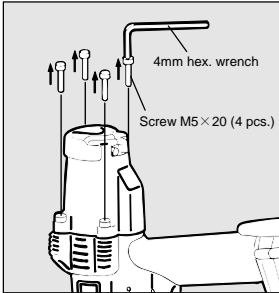

1. HOW TO REMOVE THE BIT

- ① Remove the screws M5 x 20 (4 pcs.) by using the attached 4 mm hex. wrench.

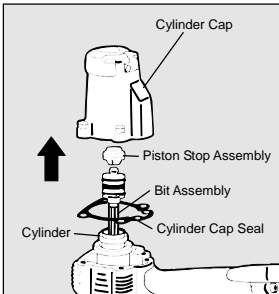

- ② Remove a Cylinder Cap. When this is done, a Bit Assembly and Cylinder Cap Seal will also come off together. Pull out the Bit Assembly attached to the Cylinder Cap.

NOTE:

- If a Piston Stop Assembly is also detached when the Bit Assembly is pulled out from the Cylinder Cap, fit the Piston Stop Assembly back into the Cylinder Cap.
- If the Bit Assembly is remaining inside the Cylinder, turn the tool upside down to remove it.

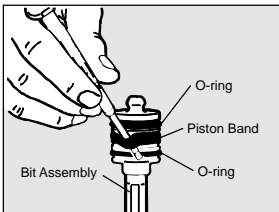

- ③ Using a regular precision screwdriver or fine nail, remove a Piston Band from the Bit Assembly.

CAUTION:

- Remove the Piston Band carefully not to cut or damage it by mistake.
- The O-ring (upper and lower) are important parts to seal the compressed air. Try not to touch them as much as possible.

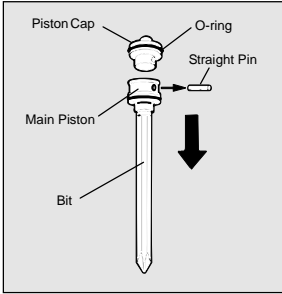

④ Remove a Straight Pin. A Main Piston and Bit come off from the Piston Cap.

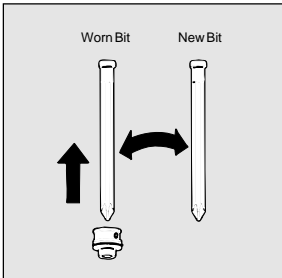

⑤ Remove the worn Bit from the Main Piston and replace with the new Bit.

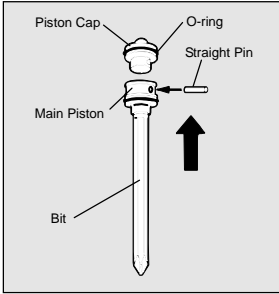

2. HOW TO ASSEMBLE

⚠ CAUTION:

When assembling, use only the specified oil and grease.

- ⑥ Using the Straight Pin, fix the new Bit, Main Piston, and Piston Cap assembled in Step ⑤ in the reverse order of Step ④.

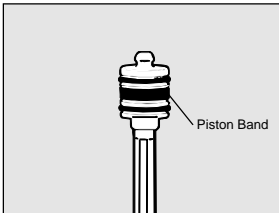

- ⑦ Fit the Piston Band into the middle groove of the Bit Assembly.

⚠ CAUTION:

Make sure that the Straight Pin has been securely inserted.

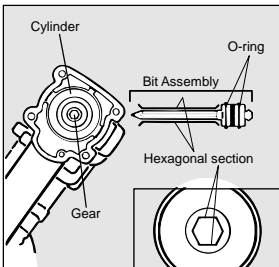

- ⑧ Align the hexagonal section of the Bit with that of the Gear and put the Bit Assembly into the Cylinder.

NOTE:

- Then, be sure to apply 10 or more drips of oil into the Cylinder.

⚠ CAUTION:

Make sure that the O-ring is not coming out of the Bit Assembly.

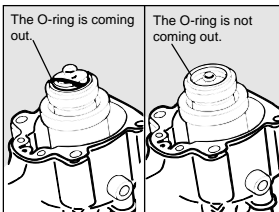

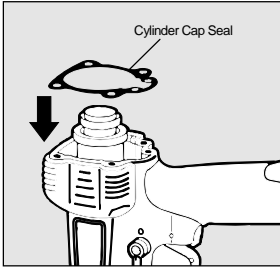

⑨ Fit a Cylinder Cap Seal onto the upper part of the body.

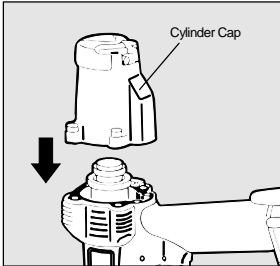

⑩ Place the Cylinder Cap onto the Cylinder Cap Seal.

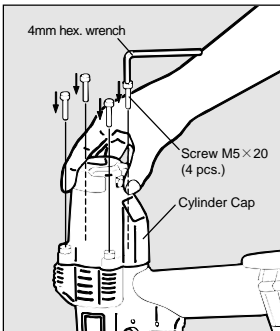

⑪ Holding down the Cylinder Cap, tighten the four Screws (M5 x 20) with the 4 mm hex. wrench.

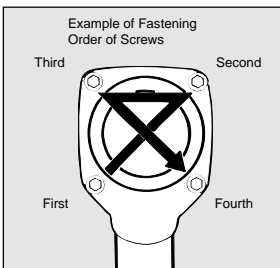

NOTE:

● Tighten the Screws evenly in the diagonal lines. Specified tightening torque should be equal 70 to 80 kgf-cm (105 to 120 in lbs.).

⚠ WARNING:

Make sure that the Cylinder Cap has been securely and uniformly clamped to the body with the four Screws (M5 x 20) at the specified tightening torque.

6. MAINTAIN FOR PERFORMANCE

① DO NOT FIRE THE NAILER WHEN IT IS EMPTY

② USE RECOMMENDED OIL

The velocite or turbine oil should be used to lubricate the tool. Upon completion of operations, place 10 drops of oil into the air plug inlet with the jet oiler. (Recommended Oil : ISO VG32)

③ INSPECT AND MAINTAIN DAILY OR BEFORE OPERATION



Disconnect air supply and empty the magazine when inspecting or maintaining the tool.

- (1) Drain air compressor
- (2) Tighten all screws
- (3) Keep contact arm moving smoothly

7. STORING

- ① When not in use for an extended period, apply a thin coat of the lubricant to the steel parts to avoid rust.
- ② Do not store the tool in a cold weather environment. Keep the tool in a warm area.
- ③ When not in use, the tool should be stored in a warm and dry place. Keep out of reach of children.
- ④ All quality tools will eventually require servicing or replacement of parts because of wear from the normal use.

8. TROUBLE SHOOTING/REPAIRS

The troubleshooting and/or repairs shall be carried out only by the MAX CO., LTD. authorised distributors or by other specialists.



Recycled paper is used for this manual and its recyclable.

- The content of this manual might be changed without notice for improvement.



[6-6 NIHONBASHI-HAKOZAKI-CHO, CHUO-KU, TOKYO, JAPAN]
Tel: (03) 3669-8131 Telefax: (03) 3669-7104

www.max-ltd.co.jp/int/ (GLOBAL Site)

www.max-europe.com (EUROPE Site)

★061201-00/00

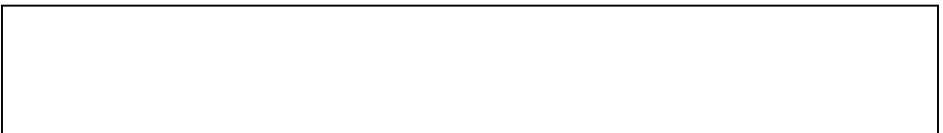

PRINTED IN JAPAN