

ENGLISH

GS690RH/GS690CH

MAX CORDLESS FASTENING SYSTEM

INDEX

1. SAFETY INSTRUCTIONS	2
2. SPECIFICATIONS & TECHNICAL DATA	9
3. SAFETY DEVICE.....	10
4. HOW TO USE THE BATTERY AND THE CHARGER.....	11
5. HANDLING OF FUEL CELL.....	15
6. INSTRUCTIONS FOR OPERATION.....	18
7. MAINTAIN FOR PERFORMANCE	21
8. STORING.....	21
9. TROUBLESHOOTING/REPAIRS	22

OPERATING and MAINTENANCE MANUAL



WARNING:

BEFORE USING THIS TOOL, STUDY THIS MANUAL TO ENSURE SAFETY WARNING AND INSTRUCTIONS.

KEEP THESE INSTRUCTIONS WITH THE TOOL FOR FUTURE REFERENCE.

1. SAFETY INSTRUCTIONS



⚠ WARNING:

TO AVOID SEVERE PERSONAL INJURY OR PROPERTY DAMAGE

BEFORE USING THE TOOL, READ CAREFULLY AND UNDERSTAND THE FOLLOWING "SAFETY INSTRUCTIONS". FAILURE TO FOLLOW WARNINGS COULD RESULT IN DEATH OR SERIOUS INJURY.

PRECAUTIONS ON USING THE TOOL



1. WEAR SAFETY GLASSES OR GOGGLES

Danger to the eyes always exists due to the possibility of dust being blown up by the exhausted air or of a fastener flying up due to the improper handling of the tool. For these reasons, safety glasses or goggles always be worn when operating the tool.

The employer and/or user must ensure that proper eye protection is worn. Eye protection equipment must conform to the requirements of the American National Standards Institute, ANSI Z87.1 (Council Directive 89/686/EEC of 21 DEC. 1989) and provide both frontal and side protection.

The employer is responsible to enforce the use of eye protection equipment by the tool operator and all other personnel in the work area.

NOTE: Non-side shielded spectacles and face shields alone do not provide adequate protection.



2. EAR PROTECTION MAY BE REQUIRED IN SOME ENVIRONMENTS

As the working condition may include exposure to high noise levels which can lead to hearing damage, the employer and user should ensure that any necessary hearing protection is provided and used by the operator and others in the work area.



3. WEAR THE CLOTHINGS AND A PROTECTIVE GEAR SUITABLE FOR THE WORKING ENVIRONMENT

Depending on the working environment, wear a long-sleeve work uniform and a protective gear such as a helmet, safety shoes.

4. CAUTIONS FOR FUEL CELL

Contains flammable gases which are under pressure. Failure to follow instructions may result in explosion or fire.



❶ **Be sure to use only MAX Fuel Cells.**

❷ **Do not store the Fuel Cell in an ill-ventilated place.**

❸ **Do not expose the Fuel Cell to the direct sunshine.**

Do not place the Fuel Cell in a vehicle or a trunk where the temperature could rise. It could explode. A used empty Fuel Cell still contains a combustible propellant gas, which could swell and explode a container into pieces.



❹ **Store the Fuel Cell at ambient temperature of 49°C (120°F) or lower.**

The Fuel Cell contains the pressurized combustible gas. If it is exposed to the temperature higher than 49°C (120°F), the gas could leak from it or burst, resulting in a fire.

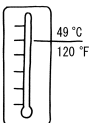



⑥ Do not breathe in the gas.



⑥ Do not incinerate or recycle the empty Fuel Cell.



⑦ Never jet the gas to the human body.



⑧ Do not remove a rubber plug from the bottom of the Fuel Cell except at disposal.



⑨ Do not make a hole in the Fuel Cell.

5. CAUTIONS FOR CHARGING METHOD, THE CHARGER AND THE BATTERY

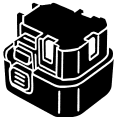

① Be sure to use MAX JP606H.

Be sure to use MAX JP606H for the tool. Never connect the tool to a power source or other rechargeable battery, dry cells or storage battery for automobiles.

Failure to do this could cause breakage, trouble, heat generation or combustion.
(See Page 11 for MAX JP606H)

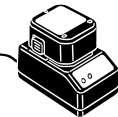

② Be sure to charge with MAX JC610M.

Be sure to charge the Battery with MAX JC610M.

If charged with other charger, it could fail to be properly charged as well as get broken, ignited or generate the heat. (See Page 11 for MAX JC610M)

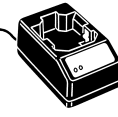

③ Charge the Battery prior to use.

The new Battery or the one which has not been used for a long period may not be fully charged due to self-discharge. Be sure to charge it with MAX JC610M.

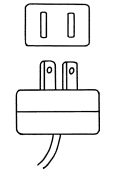

④ Charge the Battery at the specified voltage.

Be sure to charge, using a 100-240 V AC plug socket (for household use). Never charge at other than the specified voltage. Neglect of this could cause combustion or heat generation.



❸ **Never use a transformer such as a booster for the power source of the charger.**
Failure to do will cause a problem or burnout of the charger this causes a trouble or burnout of the charger.



❹ **Never use an engine generator or DC power source to charge the Battery.**
Failure to do will cause a problem or burnout of the charger this causes a trouble or burnout of the charger.



❺ **Never charge the Battery in the rain or in the place exposed to water splash or moisture.**
If it is charged in the wet condition, it could cause an electric shock or short-circuiting, resulting in a fire due to burnout or combustion.



❻ **Never touch a power plug with a wet hand.**
Holding it with a wet hand could cause an electric shock.



❼ **Never cover the charger in use with a cloth, and so on.**
Putting a cover could generate the heat, resulting in a burnout or fire.



❽ **Do not bring the charger closer to a fire.**



❾ **Do not charge the Battery near any combustible substance.**



❿ **Charge the Battery in a well-ventilated place, protected against the direct sunshine.**
Charging in the direct sunshine could overheat the charger, resulting in a burnout or fire.

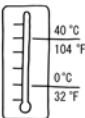

⓫ **Charge the Battery at ambient temperature of 0°C (32°F) to 40°C (104°F).**
If the ambient temperature is less than 0°C (32°F) to 40°C (104°F), charging may not be allowed, could result in a fire.



⓬ **Do not allow foreign objects into a ventilation hole or Battery plug socket in the charger.**
They cause an electric shock or trouble. Use in the place free of dust.



16. Handle a power cord with care.

If you hold the power cord of the AC adapter to carry or pull it to disconnect from a plug socket, it will be damaged, resulting in snapping or short-circuiting. Also, take care that it will not come into contact with cutters, high-temperature substances, oil or grease. Replace the damaged power cord with a new one.



16. Once the Battery is disconnected from the tool body, be sure to cover it with a pack cap, unless it is used.

In order to prevent short-circuiting, cover the terminal block (metal section) of the unused Battery with the pack cap.



17. Never short-circuit the terminal block (metal section) of the Battery.

If it is short-circuited, a large current will run to overheat the Battery, causing you a burn or damage on it.



18. Never throw the Battery into a fire.

This could cause the Battery to explode.

6. CARE SHOULD BE TAKEN WHEN CONNECTING THE BATTERY TO THE TOOL

When connecting the Battery to the tool, be sure to observe the following in order to prevent malfunctioning.

1. Do not put your finger on the trigger.
2. Do not press the contact arm against the object.
3. Never put your finger or hand near the muzzle.



7. BE SURE TO CHECK WHEN THE BATTERY IS CONNECTED

Prior to using the tool, connect the Battery to it without pressing the contact arm against the object and loading the nails and Fuel Cell, and be sure to check the following:

1. Check whether or not operating sound is heard, by only connecting the Battery.
* If you connect the Battery and press the contact arm against the floor, and so on, the fan of the tool will run, but this is not abnormal.
2. Check for heat generation or abnormal smell or sound.

If the tool is activated, generates the heat or emits abnormal smell or sound, it is an indication of trouble. Using the tool in that condition results in an accident. If any abnormality is found, contact your nearest MAX authorized distributor.



8. UNPLUG THE CHARGER WHEN IT IS NOT USED

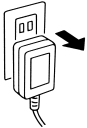

9. DO NOT USE THE TOOL IN AN ILL-VENTILATED PLACE

If used in an ill-ventilated place, you could suffer from oxygen starvation.

10. AVOID THE DIRECT SUNSHINE

Do not place the tool in a vehicle or a trunk where the temperature could rise, because it could explode. A used empty Fuel Cell still contains a combustible jet gas, which could swell and explode a container into pieces.





11. NEVER USE THE TOOL NEAR THE VOLATILE COMBUSTIBLE SUBSTANCES

Never use the tool near gasoline, thinner, gas, paint or adhesive agent, because it could ignite or explode.



12. DO NOT BRING THE TOOL CLOSE TO FIRE



13. BE SURE TO USE THE TOOL IN THE WORKING ENVIRONMENT OF -7°C (19°F) TO 49°C (120°F), BECAUSE THE TOOL BODY COULD BE DAMAGED, IGNITE OR EXPLODE

-7°C (19°F) or lower: The tool body could be damaged.

49°C (120°F) or higher: The Fuel Cell could be damaged, resulting in ignition or explosion.



14. DO NOT USE THE TOOL IN THE RAIN OR IN A VERY HUMID PLACE

Neglect of this causes a trouble.



15. NEVER DRIVE THE NAILS, FACING EACH OTHER

If you drive the nails, facing each other, an improperly driven nail may hit and injure the worker facing you.



16. BEWARE OF THE HIGH TEMPERATURE OF THE TOOL

If the tool is used for a long period of time, the nose and contact arm will become hot. Be careful not to get a burn.



17. WHEN USING THE HOOK, BE SURE TO RELEASE YOUR FINGER FROM THE TRIGGER

When using the hook, be sure to release your finger from the trigger.



18. REMOVE THE FUEL CELL AND THE BATTERY AND EMPTY THE MAGAZINE WHEN THE TOOL IS NOT IN USE

Always remove the Fuel Cell and the Battery from the tool and empty the magazine when operation has been completed or suspended, when unattended, moving to a different work area, adjusting, disassembling, or repairing the tool, and when clearing a jammed fastener.



19. INSPECT SCREW TIGHTNESS

Loose or improperly installed screws or bolts cause accidents and tool damage when the tool is put into operation. Inspect to confirm that all screws and bolts are tight and properly installed prior to operating the tool.



20. DO NOT TOUCH THE TRIGGER UNLESS YOU INTEND TO DRIVE A FASTENER

Never touch the trigger unless you intend to drive a fastener into the work. It is dangerous to walk around carrying the tool with the trigger pulled, and this and similar actions should be avoided.



21. NEVER POINT THE DISCHARGE OUTLET TOWARD YOURSELF AND OTHER PERSONNEL

If the discharge outlet is pointed toward people, serious accidents may be caused when misfiring. Be sure the discharge outlet is not pointed toward people when the Fuel Cell and the Battery are inserted or not, loading and unloading the fasteners or similar operations.

22. USE SPECIFIED FASTENERS

The use of fasteners other than specified fasteners will cause the tool malfunction. Be sure to use only specified fasteners when operating the tool.

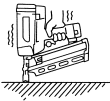

23. PLACE THE DISCHARGE OUTLET ON THE WORK SURFACE PROPERLY

The tool should be operated only when it is in contact with the work surface. Always hold the tool firm against the surface to be fastened. Failure to place the discharge outlet of the nose in a improper manner can result in a fastener flying up and is extremely dangerous.



24. KEEP HANDS AND BODY AWAY FROM THE DISCHARGE OUTLET

When loading and using the tool, never place a hand or any part of body in fastener discharge area of the tool. It is very dangerous to hit the hands or body by mistake.



25. DO NOT DRIVE FASTENERS CLOSE TO THE EDGE AND CORNER OF THE WORK AND THIN MATERIAL

The workpiece is likely to split and the fastener could fly free and hit someone.



26. DO NOT DRIVE FASTENERS ON TOP OF OTHER FASTENERS

Driving fasteners of the top of other fasteners may cause deflection fasteners which could cause injury.

27. REMOVE THE FASTENERS, FUEL CELL AND BATTERY AFTER COMPLETING OPERATION

If fasteners are left in the magazine after the completion of operation, there is the danger of a serious accident occurring prior to the resumption of operation, should the tool be handled carelessly, or when inserting the Fuel Cell and the Battery. For this reason, always remove all fasteners, Fuel Cell and Battery remaining in the magazine after completion of the operation.

28. CHECK OPERATION OF THE CONTACT TRIP MECHANISM FREQUENTLY IN CASE OF USING A CONTACT TRIP TYPE TOOL

Do not use the tool if the trip is not working correctly as accidental driving of a fastener may result. Do not interfere with the proper operation of the contact trip mechanism.



29. WHEN USING THE TOOL OUTSIDE OR ELEVATED PLACE

When fastening roofs or similar slanted surface, start fastening at the lower part and gradually work your way up. Fastening backward is dangerous as you may loose your foot place.

30. NEVER USE THE TOOL IF ANY PORTION OF THE TOOL CONTROLS (e.g., TRIGGER, CONTACT ARM) IS INOPERABLE, DISCONNECTED, ALTERED OR NOT WORKING PROPERLY

31. NEVER ACTUATE THE TOOL INTO FREE SPACE

This will avoid any hazard caused by free flying fasteners and excessive strain of the tool.

32. ALWAYS ASSUME THAT THE TOOL CONTAINS FASTENERS

33. RESPECT THE TOOL AS A WORKING IMPLEMENT

34. NO HORSEPLAY

35. NEVER LOAD THE TOOL WITH FASTENERS WHEN ANY ONE OF THE OPERATING CONTROLS (e.g., TRIGGER, CONTACT ARM) IS ACTIVATED



36. TAKE GOOD CARE OF THE TOOL

Clean the tool with dry soft cloth. Never use wet cloth or volatile solutions such as thinner, benzine.



37. AVOID THE DIRECT SUNSHINE

Do not leave the tool or Charger in the direct sunshine for a long time.

38. SECURE THE TABLE FIRMLY, WHERE THE TOOL IS PLACED, SO THAT IT WILL NOT BE DEFORMED OR TUMBLE DOWN

39. WHEN USING THE MACHINE FOR A SPECIAL PURPOSE OR IN A SPECIAL ENVIRONMENT, WHICH ARE NOT SPECIFIED IN THIS INSTRUCTION MANUAL, IT IS NECESSARY TO OBSERVE ADDITIONAL RULES AND REGULATIONS

40. USE ONLY THE MAX AUTHORIZED OPTIONAL PARTS WITH THE TOOL

41. HOLD THE FASTENER DRIVING TOOL DURING THE WORK OPERATION IN SUCH A WAY THAT NO INJURIES CAN BE CAUSED TO THE HEAD OR TO THE BODY IN THE EVENT OF A POSSIBLE RECOIL CONSEQUENT UPON A DISRUPTION IN THE ENERGY SUPPLY OR HARD AREAS WITHIN THE WORKPIECE.

OBSERVE THE FOLLOWING GENERAL CAUTION IN ADDITION TO THE OTHER WARNINGS CONTAINED IN THIS MANUAL

- Do not use the tool as a hammer.
- Do not drop or hit the tool.
- Do not apply an excessive force.
- The tool must be used only for the purpose it was designed.
- Never remove, tamper with the operating controls (e.g., TRIGGER, CONTACT ARM)
- Keep the tool, the Fuel Cell and the Battery in a dry place out of reach of children when not in use.
- Do not use the tool without Safety Warning label.
- Do not modify the tool from original design or function without approval by MAX CO., LTD.

2. SPECIFICATIONS

1. NAME OF PARTS

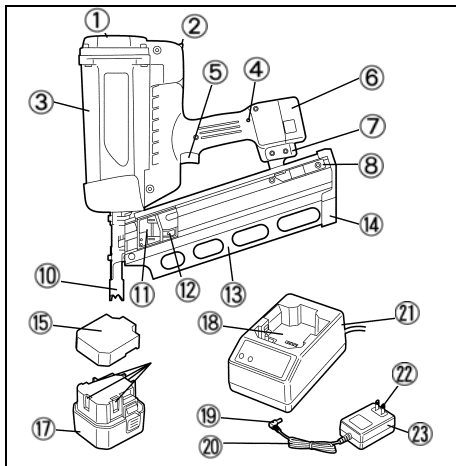

- | | |
|-----------------------------------|--------------------------|
| ① Air Filter Cover | ⑫ Pusher |
| ② Fuel Cover | ⑬ Magazine |
| ③ Body | ⑭ Tail Cover |
| ④ LED | ⑮ Pack Cap |
| ⑤ Trigger | ⑯ Terminal Block |
| ⑥ Battery | ⑰ Battery (JP606H) |
| ⑦ Hook | ⑱ Battery Setting Hollow |
| ⑧ Nail Stopper | ⑲ Jack |
| ⑨ Adjustment Dial
(Nail Depth) | ⑳ Power Cord |
| ⑩ Contact Arm | ㉑ Charger (JC610M) |
| ⑪ Pusher Holder | ㉒ Power Plug |
| | ㉓ AC Adapter |

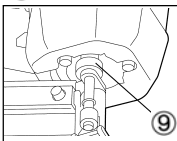

NOTE: The triangle symbol marked as “V” following its tool serial number indicates that safety yoke is equipped with this tool.

2. TOOL SPECIFICATIONS

PRODUCT NO.	GS690RH	GS690CH
HEIGHT	15" (382 mm)	15-3/8" (391 mm)
WIDTH	4-3/8" (111 mm)	4-3/8" (110 mm)
LENGTH	15" (379 mm)	13-3/8" (340mm)
WEIGHT	7.8 lbs. (3.5 kg) (including Fuel Cell and Battery)	
LOADING CAPACITY	32 nails (1 strip)	40 nails (1 strip)
BATTERY	Battery JP606H for MAX Cordless Fastening System	
BATTERY CAPACITY	6V DC, 1.5 Ah	
CHARGER	Charger JC610M for MAX gas nailer (AC adapter included)	
POWER SOURCE	100-240V AC, 50 or 60 Hz	
POWER CONSUMPTION (Rated output)	8VA (10V 800mA)	
CHARGING TIME	150 minutes at maximum	
ACCESSORIES	Carrying case, Battery, Charger	

3. FASTENER SPECIFICATIONS

PRODUCT NO.	GS690RH	GS690CH
NAIL LENGTH	2" to 3-1/2" (50 to 90 mm)	
SHANK DIAMETER	.113" to .131" (2.9 to 3.3 mm)	
SHANK TYPE	Smooth, Ring, Screw	
HEAD DIAMETER	.267" to .295" (6.8 to 7.5 mm)	.256" to .303" (6.5 to 7.7 mm)
COLLATION ANGLE	21 degree	34 degree
HEAD	Full round head	Clipped head

4. TECHNICAL DATA

● NOISE

A-weighted single-event ----- LWA, 1s, d 105.4 dB
sound power level

A-weighted single-event ----- LpA, 1s, d 98.8 dB
emission sound pressure
level at work station

These values are determined and documented in accordance to EN12549 : 1999.

● VIBRATION

Vibration characteristic value = 4.46 m/s²

These values are determined and documented in accordance to ISO 8662-11.

This value is a tool-related characteristic value and does not represent the influence to the hand-arm-system when using the tool. An influence to the hand-arm-system when using the tool will for example depend on the gripping force, the contact pressure force, the working direction, the workpiece, the workpiece support.

3. SAFETY DEVICES

The tool is provided with the following safety devices in order to secure safety for nail driving work.

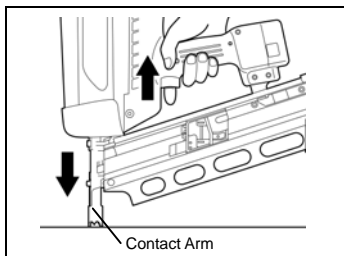

Mechanical Safety Device

This tool is equipped with a FULL SEQUENTIAL ACTIVATION MECHANISM. This tool will not discharge nails unless the Contact Arm and Trigger have been activated simultaneously. The nails are not discharged by neither simply pulling the Trigger nor applying the Contact Arm to the nails driving object. The nails are discharged only after apply the Contact Arm to the object and pulling the Trigger.

CAUTION:

- Prior to using the tool, be sure to inspect it to see whether the safety devices function properly. Do not use it if they do not function properly. Prior to using the tool, check whether the safety devices function properly. With no nails loaded, install the Battery and Fuel Cell to check.
- * In the following cases, the safety devices are out of order. Never use the tool.
 1. An operating sound is emitted by simply pulling the trigger.
 2. The tool starts dry-fire operation by simply applying the contact arm to the object.
- * A fan running sound is heard, but this is not a fault.

If any abnormality is found, contact your nearest MAX authorized distributor for inspection/repairing.

4. HOW TO USE THE BATTERY AND THE CHARGER

⚠WARNING:

- Be sure to charge MAX JP606H for the tool with MAX JC610M. If charged with other charger, the Battery could fail to be properly charged as well as get broken, ignited or generate the heat.
- Do not put the Battery close to a fire.
- Do not leave the Battery in the direct sunshine.
- Do not charge or use the Battery in the wet condition with a liquid such as water, sea water, milk, soft drink, soap water.
- Unplug the charger when it is not used.
- Be sure to charge at 0 to 40°C to avoid the possibility of fire.
- Do not give a strong shock such as hitting with a hammer, stamping or dropping.

⚠CAUTION:

- When the Battery has been used up or is not used for a long period, remove it from the Charger.
- After setting the Battery in the tool, do not hold it to carry around.

PROPER USE OF BATTERY

① Fully charge and use up the Battery.

If you repeat charging the Battery while stored electricity still remains more than half the capacity, the number of nails drivable by each charging could decrease dramatically, shortening the life of the Battery. It is recommended to use it until the LED of the tool has been illuminated in red, indicating that the Battery running out of electricity.

② Use two Batterys alternately.

To ensure the longer life of the Battery, it is recommended to use two of them alternately, one in use while the other is charging preparing a spare one.

⚠CAUTION:

- Do not use the out-of-life Battery.
Use of the out-of-life Battery leads to breakdown of the tool body, and charging it causes the charger to go wrong.

Recycling the Ni-MH Battery

The Battery for the tool uses Ni-MH batteries which are a precious recyclable resource. Once the Battery runs out of life, take it to your nearest distributor without disposing of it.

⚠WARNING:

- In order to prevent short-circuiting, be sure to cover the terminal block (metal section) of the Battery with the Pack Cap (wind the insulating tape) for recycling.

<Battery cells in Battery Pack>

- Nominal voltage: 1.2 V/piece
- Quantity used in 1 pack: 5 pieces

HOW TO USE THE CHARGER

The special purpose charger JC610M has the LEDs (green, red) which indicate the status of the charger and Battery.

	Green LED	Red LED	Status	Description
1.	○ ON	● OFF	Power-on	The charger has been plugged in. (Power-on status: Battery unset)
2.	● OFF	○ ON	Charging	The Battery is being charged.
3.	○ ON	● OFF	Charge Completed	The Battery has been completed charged.
4.	Blinking	Blinking	High temperature alarm	The Battery is hot. (Remove it from the Charger and cool it down for a while before charging.)
5.	○ ON	○ ON	Battery alarm	The Battery is defective. (Replace it with a new one)
6.	Blinking	○ ON	Battery high temperature alarm	The Battery is defective and hot. (Replace it with a new one.)

Troubles of Charger and Battery

The following cases are considered to be the troubles. Replace the charger and Battery with new ones.

- The green LED is not turned on if the power plug of the charger is plugged into a 100-240 V AC (for household use) plug socket. (With the Battery unset)
- * Check with another electric appliance to see whether electricity is available at the plug socket.
- Neither green nor red LED is turned on or blinks if the Battery is set in the Charger.
- The green LED is not turned on 150 minutes after the red one has been turned on.
- The red LED is not turned on if the Battery is set in the charger.

HOW TO CHARGE

⚠ WARNING:

- **Charge the Battery at the specified voltage.**
Be sure to charge from a 100-240 V AC (for household use) plug socket. Use of the non-specified voltage not only causes a trouble, but also is dangerous.
- **Handle the power cord with care.**
Do not use the Charger whose power cord is damaged.
- **Use a proper plug socket.**
Use of the rickety or slack plug socket causes an accident due to overheat. If this is the case, use another proper one.

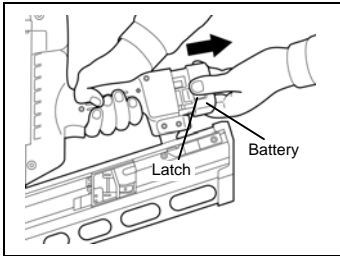

- ① If the Battery is used up, remove it from the tool.
Firmly holding the tool body, press the latches on both side of the Battery with your fingers to remove.

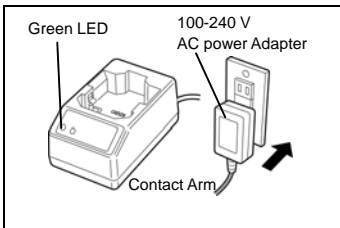

- ② **Insert the AC adapter's jack into the Charger and plug the power plug into a plug socket.**
The green LED is turned on to inform you of the power-on status.

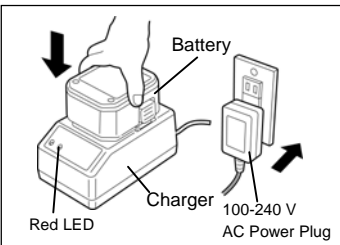

- ③ **Charge the Battery.**
 1. Set the Battery firmly in the charger.
 2. Once it is set in the charger, charging will start automatically. The red LED is turned on to inform you that charging is under way.
 3. The maximum charging time is approx. 150 minutes. The charging time depends on the temperature, supply voltage or remaining battery capacity. Once charging is fully completed, the green LED will be illuminated to inform you that charging has been completed. If the fully charged Battery is set in the charger again, the red LED will be turned on again, indicating that it is being charged. This is not an abnormality. After a while, the green LED will be turned on to indicate completion of charging.

⚠ CAUTION:

- **Do not try to charge the Battery which has been fully charged. The life of the Battery could be shortened.**

- ④ **The Illuminated Green LED Indicates completion of charging.**
 1. Holding down the charger, remove the Battery.
 2. Disconnect the AC adapter's power plug from the plug socket.

Now Charging is complete.

Preventing the Battery Pack from becoming inactive

In the following cases the Battery Pack must be charged for 12 HOURS to reach top performance:

- Upon purchasing the tool.
- When the tool has not been used for 1 month or longer.
- When it is clear that you can drive less nails even when fully charged.

After the Charge Complete lamp has been turned on, leave the Battery set in the Charger for about another 12 hours.

CAUTION:

- **After completing your work or when the tool is not used, be sure to remove the Battery Pack from the tool to store it. (Remove the Fuel Cell and nails as well) If it is left connected, the electric power will be consumed in the standby state.**

5. HANDLING OF FUEL CELL

The Fuel Cell is double structured; the inner container has been filled with a liquid fuel gas and the outer one with a propellant gas (another pressurized gas).

Like squeezing a toothpaste tube, the inner fuel gas is pushed out by the pressure of the propellant gas, thus being used up to the last without wasting it. Because of this structure, the combustible propellant gas in the outer container remains even after the fuel gas in the inner container has been used.

Therefore, utmost care should be taken when disposing the empty Fuel Cell.

⚠ WARNING:

- Be sure to use the Fuel Cell exclusively designed for the MAX Cordless Fastening System.
- Never smoke a cigarette when attaching or operating a jet valve.
- Do not remove a rubber plug from the bottom of the Fuel Cell except at disposal.
- Do not make a hole in the Fuel Cell.
- Be careful not to breathe in the gas.
Breathing in the gas could cause sleepiness, dizziness or nausea.
- Never jet the gas to the human body.
- Do not incinerate or recycle the empty Fuel Cell.
(See Page 19 for disposal of the Fuel Cell)

ATTACHING THE METERING VALVE TO THE FUEL CELL

The metering valve is designed to jet a constant amount of fuel gas into the combustion chamber of the tool.

1. Push to remove the valve.

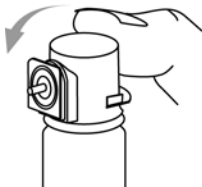

2. Detach the valve from the cap.

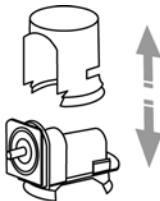

3. Align the edges.

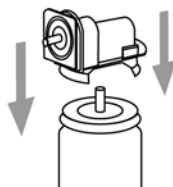

4. Push in the front edge



5. Push in the rear edge until it has clicked.

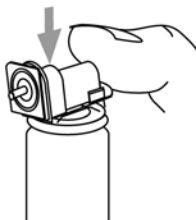

6. Push in horizontally. It clicks again.

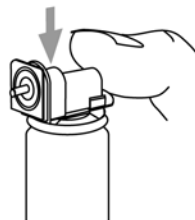

⚠ WARNING:

- Attach the metering valve properly to the Fuel Cell. Attach it firmly until it has “clicked.” Unless it is properly attached, the fuel gas will not be jetted from the metering valve. Also, the gas could leak, causing danger to you.

SETTING THE FUEL CELL



- Be sure to release your finger from the Trigger.
- Do not press the Contact Arm against the object.

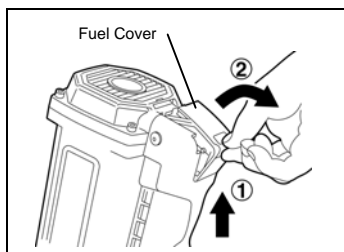

- ① Push up and pull the Fuel Cover to this side to open it.

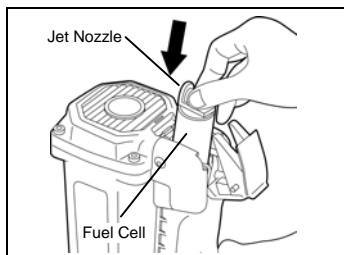

- ② Directing the Jet Nozzle of the Metering Valve forward (toward the Air Filter Cover), set the Fuel Cell.

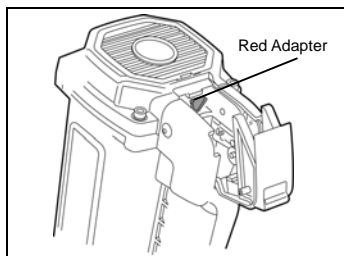

- ③ When you open the Fuel Cover, you can see a Red Adapter. Fit the Jet Nozzle into this adapter.

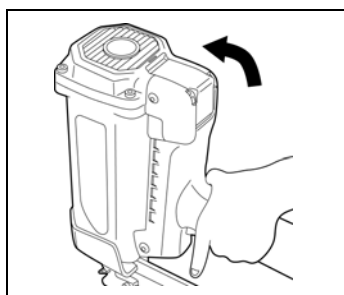

- ④ Put the Fuel Cover over the metering valve and push it down to latch.

DISPOSING OF THE USED FUEL CELL

Combustible propellant gas still remains in the used Fuel Cell.

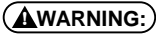

- Do not throw the used Fuel Cell into a fire.
- Never smoke a cigarette.
- Never breathe in the gas.

Dispose of all empty Fuel Cells. Remember to dispose of these cells where they will not be found by children, crushed, punctured, or burned.

6. INSTRUCTIONS FOR OPERATION

Read section titled “SAFETY INSTRUCTIONS”.

1. BEFORE OPERATION

- 1 Wear Safety Glasses or Goggles.
- 2 Do not insert the Fuel Cell and Battery.
- 3 Inspect screw tightness.
- 4 Check operation of the Contact Arm & Trigger if moving smoothly.
- 5 Insert the Fuel Cell and Battery.
- 6 Hold the tool with finger-off the Trigger, then push the Contact Arm against the work-piece. (The tool must not operate.)
- 7 Hold the tool with Contact Arm free from work-piece and pull the Trigger. (The tool must not operate.)
- 8 Remove the Fuel Cell and Battery.

⚠️WARNING:



2. OPERATION

Wear safety glasses or goggles

Danger to the eyes always exists due to the possibility of dust being blown up by the exhausted air or of a fastener flying up due to the improper handling of the tool. For these reasons, safety glasses or goggles shall always be worn when operating the tool.

The employer and/or user must ensure that proper eye protection is worn. Eye protection equipment must conform to the requirements of the American National Standards Institute, ANSI Z87.1 (Council Directive 89/686/EEC of 21 DEC. 1989) and provide both frontal and side protection.

The employer is responsible to enforce the use of eye protection equipment by the tool operator and all other personnel in the work area.

NOTE: Non-side shielded spectacles and face shields alone do not provide adequate protection.

⚠️WARNING:



Keep hands and body away from the discharge outlet

When driving the fasteners because of dangerous of hitting the hands or body by mistake.

LOADING THE NAILS

⚠️WARNING:

- When loading the nails, be sure to release the finger from the Trigger.
- Do not press the Contact Arm against the object.

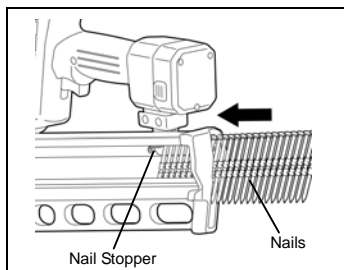

Procedure

- 1 Load the nails into the slit in the rear of the Magazine until they reach in front of the Nail Stopper.

⚠️CAUTION:

- Abrupt release of the Pusher Holder causes jamming of nails or dry-firing.

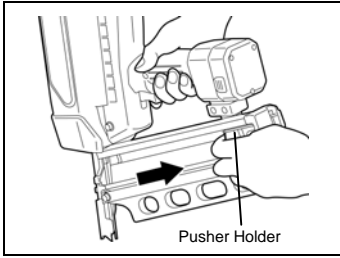

- ② Pull the Pusher Holder as far as the rear end of the magazine and release it gently.

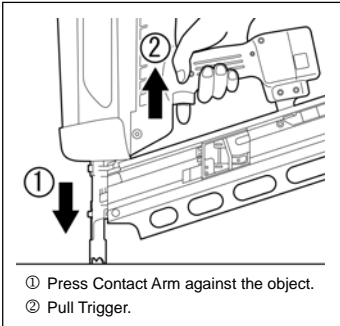

- ① Press Contact Arm against the object.
- ② Pull Trigger.

HOW TO DRIVE THE NAILS

Procedure

- ① Set the Battery and Fuel Cell in place.
- ② Press Contact Arm against where you want to drive the nails.
The fan motor is activated, the fuel gas is jetted, mixing the fuel with the air.
- ③ Firmly pressing the Contact Arm, pull the Trigger. The nails are driven into the object by combustion of the fuel.

⚠WARNING:

- Never put your face above the tool. Recoil of the tool may cause an unexpected injury.
 - Never bring your hand or finger close to the discharge outlet.
- ④ The nails are not fired again even if the Contact Arm is applied to the object with the Trigger pulled. Release the Trigger and repeat Step ②.

⚠WARNING:

- Prior to starting work, be sure to check whether the tool functions as mentioned above.
 - If the tool is used for a long time, it could be heated and burn you.
If any abnormality is found, contact your nearest MAX authorized distributor for inspection and repairing.
- * The fan keeps running for approx. 10 seconds even after driving the nails.

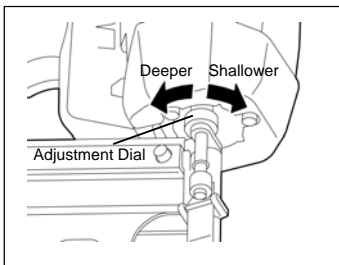

DRIVING DEPTH ADJUSTMENT

⚠WARNING:

- ALWAYS remove Fuel Cell and Battery before making adjustment.
- Pay attention for heating-up of the Adjustment Dial.
- The adjustment Dial may become hot when the tool has been used constantly.

The driving depth adjustment is made by adjusting the Adjustment Dial.

- ① With Fuel Cell and Battery set, drive a few nails into a representative material sample to determine if adjustment is necessary.
- ② If adjustment is required, remove Fuel Cell and Battery.
- ③ Refer to the mark on the Magazine for direction to turn the Adjustment Dial.
- ④ Reinstall Fuel Cell and Battery.

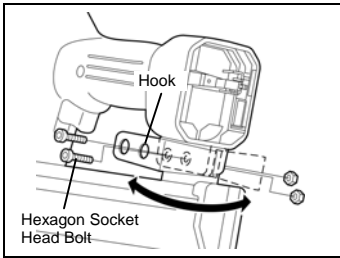

CHANGING THE HOOK DIRECTION

⚠WARNING:

- **Remove the Fuel Cell and Battery.**

The Hook can be directed in the two directions. Remove the hexagon socket head bolts with hexagonal wrench, change the direction, and then, put back the bolts to reassemble.

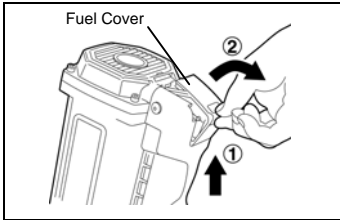

REPLACING THE FUEL CELL

If the Fuel Gas is running out, the nails cannot be driven.

⚠WARNING:

- **Be sure to release the Trigger.**
- **Do not press the Contact Arm against the object.**

① Push up and pull the Fuel Cover to this side to open it.

② Nip the Metering Valve and remove the used Fuel Cell.

③ Set the new Fuel Cell.

(See Page 18 for the setting method)

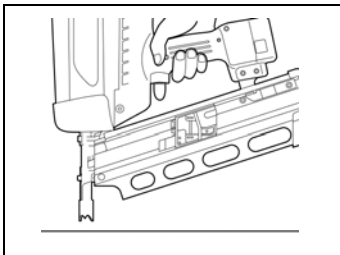
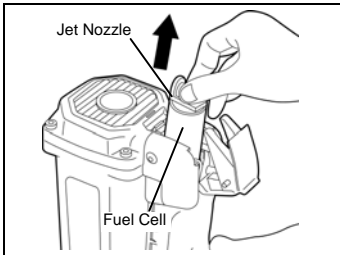

REPLACING THE BATTERY

If the Battery is running out, the red LED of the tool will be turned on.

⚠WARNING:

- **Be sure to remove the Fuel Cell.**
- **Release the Trigger.**
- **Do not press the Contact Arm against the object.**

① Firmly holding the main body, press the latches on both sides of the Battery to remove it.

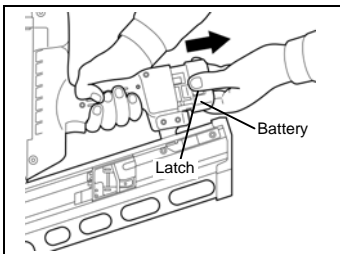

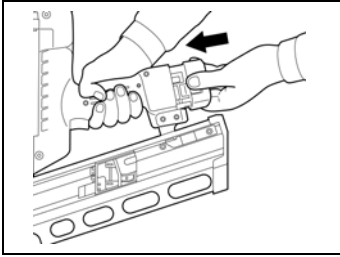

- ② Set the newly charged Battery into the main body until it has clicked.
(See Page 15 for the charging method)
- ③ Set the Fuel Cell.
(See Page 18 for the setting method)

7. MAINTAIN FOR PERFORMANCE



1. HANDLE THE TOOL WITH CARE

Never drop, collide or hit the tool against a hard material. It may be deformed, cracked or broken.



2. DO NOT TRIGGER THE TOOL WITH NO NAILS LOADED

If you repeatedly operate the tool with no nails loaded, the durability of each section will be reduced.



3. INSPECT THE TOOL PERIODICALLY

In order to maintain the performance of the tool, clean and inspect the tool periodically. To have it inspected, contact MAX authorised dealers.



4. CLEAN THE AIR FILTER

Clean the Air Filter every other day. Open the Air Filter Cover with a regular screwdriver, remove the Air Filter from the inside and clean it with an air gun, and so on.

8. STORING

- ❶ When not in use for an extended period, apply a thin coat of the lubricant to the steel parts to avoid rust.
- ❷ Do not store the tool in a cold weather environment. Keep the tool in a warm area.
- ❸ When not in use, the tool should be stored in a warm and dry place. Keep out of reach of children.
- ❹ All quality tools will eventually require servicing or replacement of parts because of wear from the normal use.

9. TROUBLE SHOOTING/REPAIRS

① The repairs shall be carried out only by the MAX authorised dealers.

② Removing Jammed Nail

⚠WARNING:

● Remove the Fuel Cell and Battery.

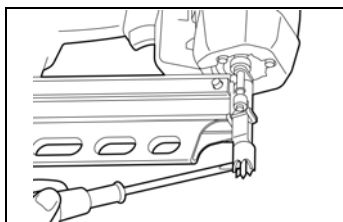

Procedure

- ① Take out the nails from the inside of the Magazine.
- ② Remove nails that are jammed inside the Nose by using a punch or slotted screw driver.

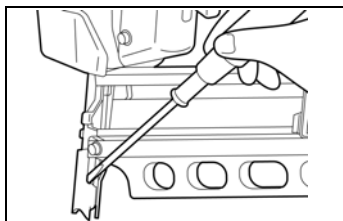

●

Phenomenon	Check Item
The Battery cannot be charged.	<ul style="list-style-type: none"> · The AC adapter's power plug is firmly connected to the plug socket. · The AC adapter's jack is firmly inserted into the charger. · The Battery is properly set in the charger. · The charger's LED is turned on.
While charging, the charger, AC adapter and power cord are heated, emit abnormal sound or generate the heat.	<ul style="list-style-type: none"> · Stop using them immediately and consult your nearest dealer.
The nails cannot be driven.	<ul style="list-style-type: none"> · The tool body is properly loaded with the nails, Battery and Fuel Cell. · The Fuel Cell is not empty. · The battery capacity is still remaining. · The nails are not jamming. · The Contact Arm is properly pressed against the object.



[6-6 NIHONBASHI-HAKOZAKI-CHO, CHUO-KU, TOKYO, JAPAN]
[Tel: (03) 3669-8131 Telefax : (03) 3669-7104]

<http://www.maxusacorp.com> (USA Site)
<http://www.max-ltd.co.jp/int/> (GLOBAL Site)

